

Article number: 6041651290006

Description: Clamping plate for belts HTD 3M 6

Measures

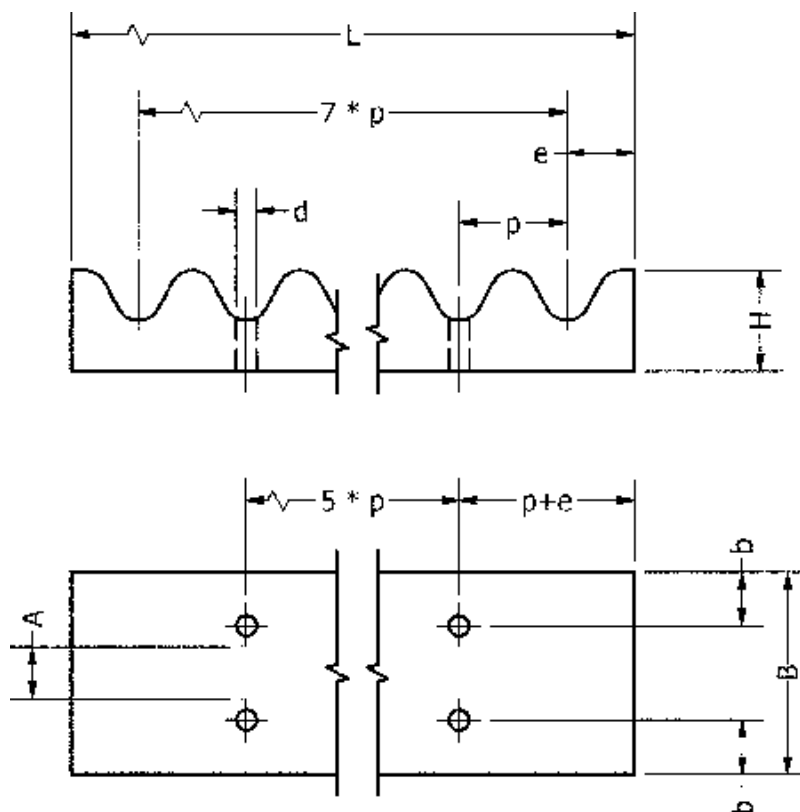

= -	b = 5
= -	B = 21
= -	d = 4.5
= -	e = 2
= -	H = 5
= -	L = 25
= -	
A = 6	